

REVISION HISTORY			
REV	DESCRIPTION	DATE	APPROVED

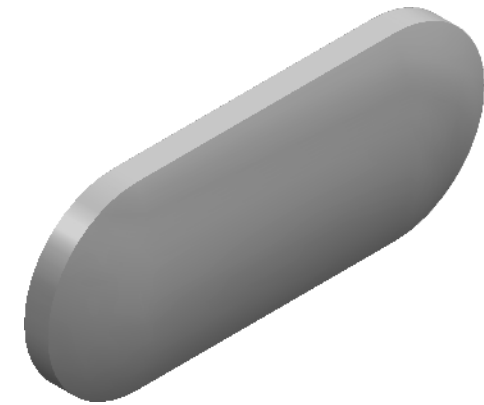
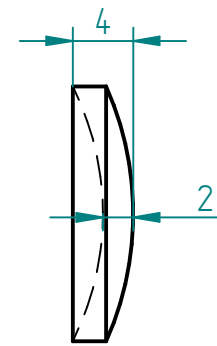
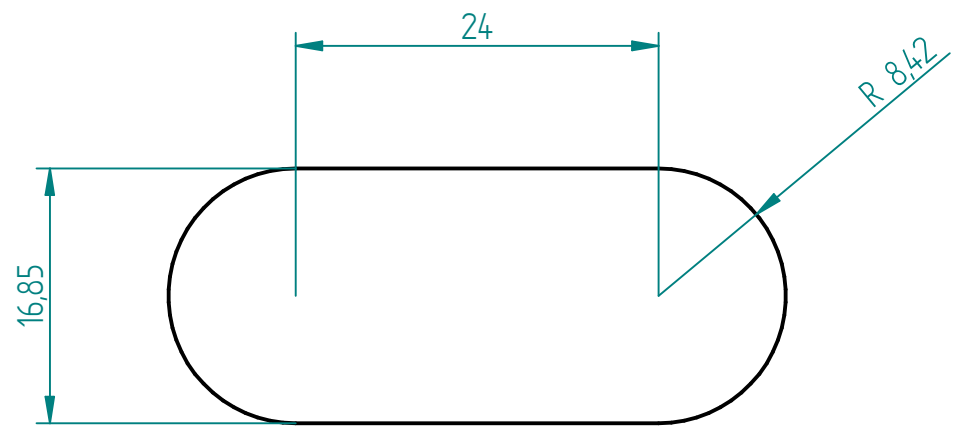

	NAME	DATE	Solid Edge		
DRAWN	Robert	04/05/22			
CHECKED					
ENG APPR					
MGR APPR			TITLE		
UNLESS OTHERWISE SPECIFIED DIMENSIONS ARE IN MILLIMETERS ANGLES ±X.X° 2 PL ±X.XX 3 PL ±X.XXX			SIZE	DWG NO	REV
			A3		
			FILE NAME: 17X41 KONKERVPROP.dft		
			SCALE:	WEIGHT:	SHEET 1 OF 1